

**Fiber Optic Thermometer “AMOTH”**

**FL-2000**

**User’s Manual**

FHE-90035

**7th edition**

May 2023

**Anritsu Meter Co., Ltd.**





**Make sure to read this user's manual to operate the temperature measuring instrument safely.**

Read this user's manual thoroughly before use to ensure safe operation of this product. Keep this manual in a convenient place for future reference.



**Warning**

Make sure to observe the following instructions. Ignoring these may result in death or serious injury caused by fire or electrical shock.

**Never use this product for purposes other than temperature measurement.**

**Never allow water or foreign object to enter the product.**

- This may cause fire, electrical shock or product failure.
- Contact the distributor or Anritsu Meter for repair if water or foreign object caused product failure.

**Never try to disassemble or modify the product.**

- This may result in personnel injury caused by fire, electrical shock or abnormal behavior of the product.
- Contact the distributor or Anritsu Meter to check or repair inside the product.

**Ensure correct polarity for battery.**

- Incorrect polarity may cause fire, damage or product failure.
- In case battery leakage occurs, contact the distributor or Anritsu Meter for repair.



## **Caution**

Make sure to observe the following instructions. If not, injury or damage to peripheral equipment may be caused.

### **Do not touch the power plug with wet hands.**

- This may cause electrical shock.

### **Install the product on a stable surface.**

- Avoid installing the product on an unstable table or inclined surface. The product may fall and cause personnel injury.

### **Arrange cables properly.**

- Tripping over the power cable or sensor cable for temperature measurement may cause the product to fall or topple, and lead to personnel injury. Careful arrangement of cables is necessary.

## Preface

Thank you for purchasing the Anritsu Meter product.

This user's manual is provided to ensure correct operation of our product.

Please read this manual thoroughly and familiarize yourself with each function of the product before use.



This instrument uses blue light for temperature measurement.

The blue light may be emitted to outside if the sensor is not connected or the sensor is damaged.

In this case, avoid looking at the blue light directly for a long time.

Doing so may cause eye strain or visual loss.

## Warranty

Our products are carefully inspected before shipment. However, if the product arrives defective due to manufacturing faults or mishandling during transportation, contact your distributor or Anritsu Meter.

Our products are warranted for one year from the date of delivery. Failure occurred within the warranty period will be repaired with no charge, provided that the failure is attributable to Anritsu Meter.

Please note that the following cases will not be covered by this warranty in any circumstances.

- Failure resulting from natural disaster such as fire and earthquake.
- Failure caused by misuse, inappropriate handling or modification.

(Opening case or loosening screws is regarded as a modification.)

## After-sales service

If you feel the instrument is not working well, consult this manual to examine the cause of the problem. If it does not help improve the situation, contact your distributor or Anritsu Meter.

Repairs within the warranty period are accepted according to the contents in the warranty card. After the warranty period expires, we will repair the product at the customer's expense if the repair is expected to improve and maintain the product performance.

When you are to return the product to Anritsu Meter for repair or periodic calibration, reuse the case and packing material originally used. If it is not possible, wrap the product with appropriate cushioning material to prevent any damage to the product during transportation.

## Caution

- Use the specified fiber sensor only.
- Read also the user's manual of the sensor to be used.
- Reprinting this manual in whole or in part without permission is prohibited.
- Every effort has been made to ensure that the information in this manual is accurate. However, if any important information is omitted or any doubts or error is found in this manual, please contact us or the distributor.
- We assume no responsibility for any results obtained by the use of this product.
- The contents of this manual or specifications of this product are subject to change without notice.
- **Avoid installing the instrument and interface cable where it may be affected by electromagnetic noise.**

## Table of Contents

<b>1. Product Name FiberOptic Thermometer</b> .....	<b>1</b>
<b>2. Product Model FL-2000</b> .....	<b>1</b>
<b>3. Product Overview</b> .....	<b>1</b>
<b>4. Packing</b> .....	<b>1</b>
4.1 Unpacking.....	1
4.2 Repacking.....	1
<b>5. Part Names and Functions</b> .....	<b>2</b>
5.1 Outer Appearance .....	2
5.2 Part Names and Functions .....	3
<b>6. Operation</b> .....	<b>5</b>
6.1 Preparation of Operation.....	5
6.1.1 Connecting Sensor.....	5
6.1.2 Fuse .....	5
6.1.3 Connecting Power Cable .....	6
6.1.4 Connecting Power Cable to Outlet .....	6
6.1.5 Setting AA-size Alkaline Batteries .....	7
6.2 Operating Instructions .....	8
6.2.1 Power ON .....	8
6.2.2 Start/Stop Measurement .....	8
6.2.3 Recording Measured Data .....	9
6.2.4 Calibration .....	12
6.2.5 RS-232C Communication.....	16
6.2.6 Analog Output .....	17
6.2.7 Error Display and Remedies .....	18
<b>7. Maintenance</b> .....	<b>19</b>
7.1 Storing the Product .....	19
7.2 Cleaning Case .....	19
7.3 Relocation.....	19
<b>8. Specifications</b> .....	<b>20</b>
<b>9. Warranty</b> .....	<b>22</b>

**1. Product Name**                      **Fiber Optic Thermometer**

**2. Product Model**                    **FL-2000**

**3. Product Overview**

This instrument is a temperature measurement instrument designed to obtain temperature data by measuring the variation in fluorescence decay time of fluorescent material as temperature changes using optical fiber.

Since this instrument uses light for measurement, it enables temperature measurement of high-frequency microwave field, magnetic field, high-voltage/high-current applied material or explosive material, which is difficult to measure accurately with conventional methods.

Also, this instrument is equipped with internal memory, RS-232C communication function and analog output function. These functions offer you various uses of temperature data by transporting them to your computer, including drawing graphs, creating records and connecting to a recorder.

**4. Packing**

4.1 Unpacking

When unpacking the product, check if all the following items are included. The product is carefully packed before shipment, however if any item is excluded or damaged, or if any error or incompleteness is found in the warranty card, please contact your distributor or Anritsu Meter. Please keep the warranty card in a safe place. Without it you may not be able to receive charge-free repair service during the warranty period.

Item	Qty
Main unit	1
Power cable (two-wire plug attached)	1
Fuse (2A mini fuse)	1
Analog output cable	1
Communication cable	1
PC software (CD ROM)	1
User's manual (for main unit and software)	1 copy each
FL-2000 user registration form for FAX	1

4.2 Repacking

When moving this product (transport to another location or carry by car), reuse the originally used case and packing material. If it is not possible, wrap the product with appropriate cushioning material to prevent any damage to the product.

Use a dry, dust-free packing material since dust or moisture could damage the product.



## 5. Part Names and Functions

### 5.1 Outer Appearance

Front side

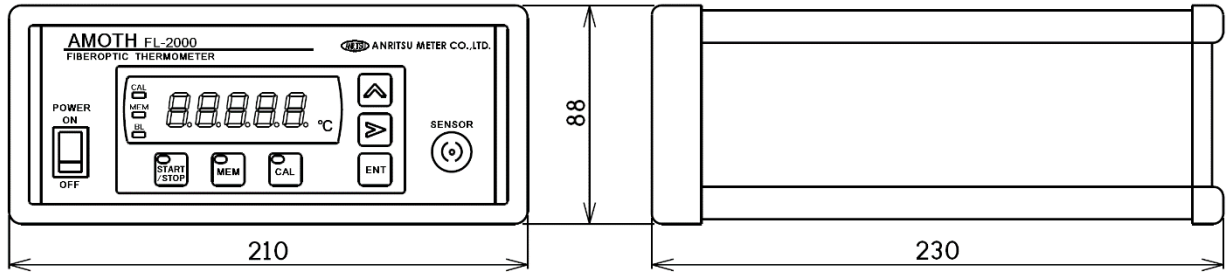

Rear side

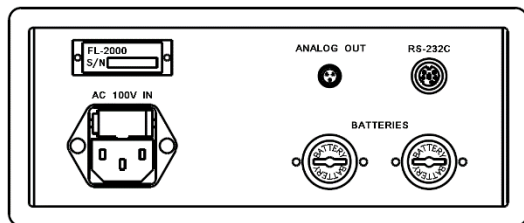

## 5.2 Part Names and Functions

<Front side>

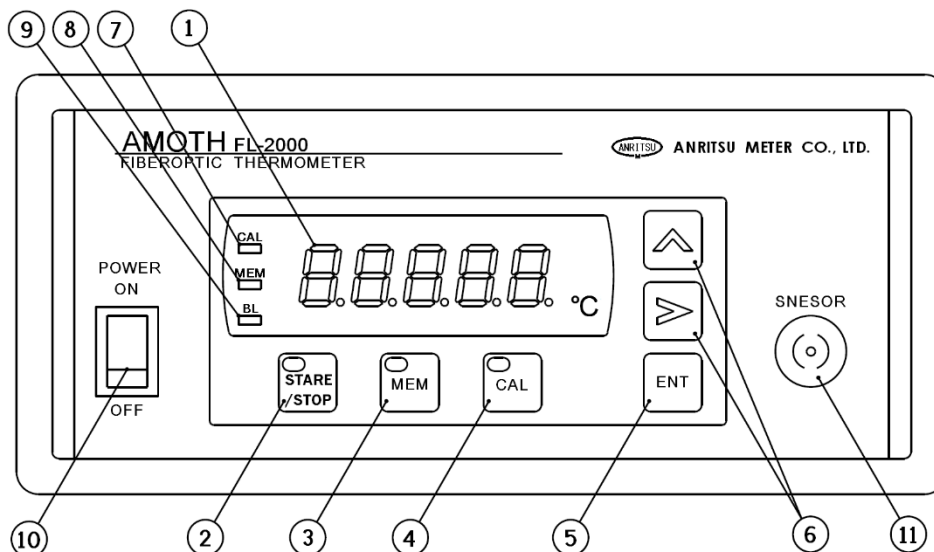

- (1) **Display**  
Indicates measured data, calibration temperature and measurement error.
- (2) **Start/Stop key (START/STOP)**  
Starts or stops measurement.
- (3) **Memory key (MEM.)**  
Records measured data.
- (4) **Calibration key (CAL.)**  
Sets calibration temperature and executes/cancels calibration.
- (5) **Enter key (ENT.)**  
Determines a value made with the cursor key. Indicates the remaining memory if calibration has not been executed.
- (6) **Cursor key (↶↷)**  
Used for calibration setting.
- (7) **Calibration executing lamp (CAL)**  
Lights while executing calibration.
- (8) **Low memory warning lamp (MEM)**  
Blinks when the remaining memory becomes 300 or lower, and lights steadily when the remaining memory reaches 0.
- (9) **Low battery warning lamp (BL)**  
Lights when the remaining battery level becomes low.
- (10) **Power switch (POWER)**  
Turns ON/OFF the power.
- (11) **Sensor connector (SENSOR)**  
Connects a fiber optic sensor (FS series).

<Rear side>

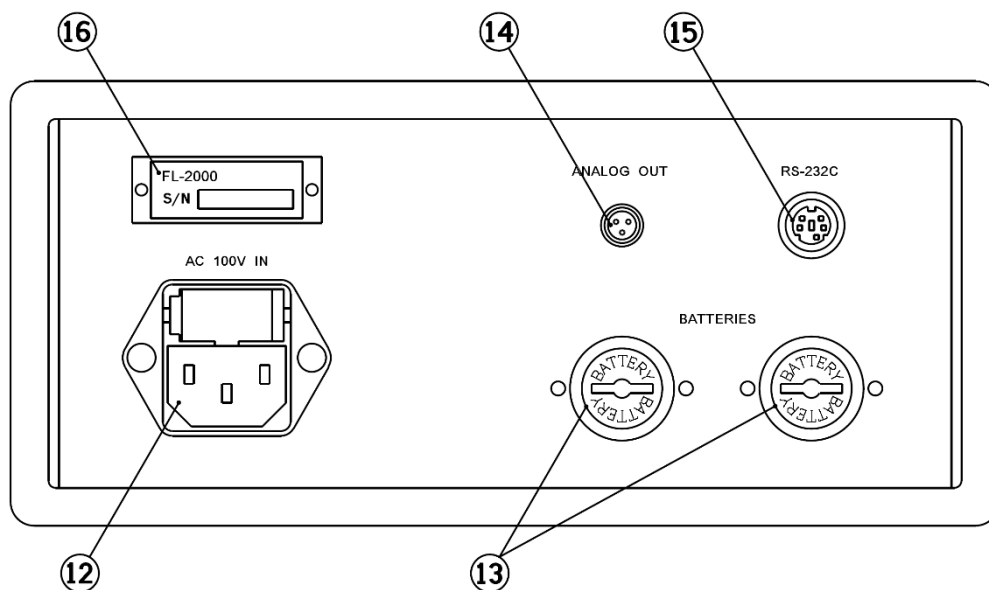

(12) **100V AC power connector** (fuse holder attached)

Connects a 100V AC power connector with ground terminal. The upper holder contains 2A mini fuse.

(13) **Battery holder** (BATTERIES)

Each holder contains three AA-size alkaline batteries (six batteries in total). This is used when AC power supply cannot be arranged for measurement.

(14) **Analog output connector** (ANALOG OUT)

Outputs 10mV per degree Celsius. Using the provided analog output cable, you can connect the instrument to a voltage recorder.

(15) **Connector for communication connection** (RS-232C)

Connect the provided communication cable to communicate with a personal computer.

Using the provided software, you can operate the instrument or retrieve recorded data from your computer.

(16) **Product nameplate**

Indicates the product name and serial number.

## 6. Operation

### 6.1 Preparation of Operation

Connect the peripherals as described below to operate this instrument.

#### 6.1.1 Connecting Sensor

Connect a temperature sensor to the sensor connector (SENSOR) on the front side of the instrument as shown below. At this time, align the protrusion of the sensor with the indentation in the sensor connector of the instrument, and then rotate the key ring until it stops to connect the sensor to the instrument.

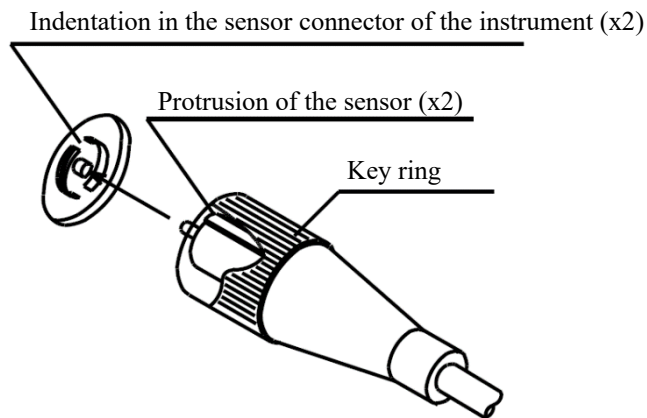

#### NOTE

- Use the specified temperature sensor only.  
Using a sensor other than the specified sensor cannot provide accurate measurement and it may damage the instrument.

#### 6.1.2 Fuse

The fuse holder located on the rear side of the instrument contains 2A mini fuse. Pull out the fuse holder as shown below and check if 2A mini fuse is attached.

**⚠ Caution**      **Make sure to remove power cable before pulling out fuse holder.**

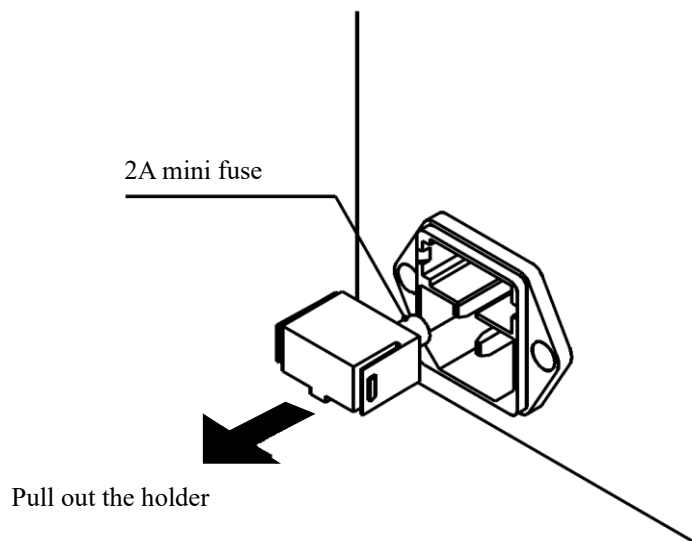

### 6.1.3 Connecting Power Cable

As shown in the figure below, connect the power cable to the 100V AC power connector on the rear side of the instrument.

**⚠ Caution**      **Make sure to power OFF before connecting.**

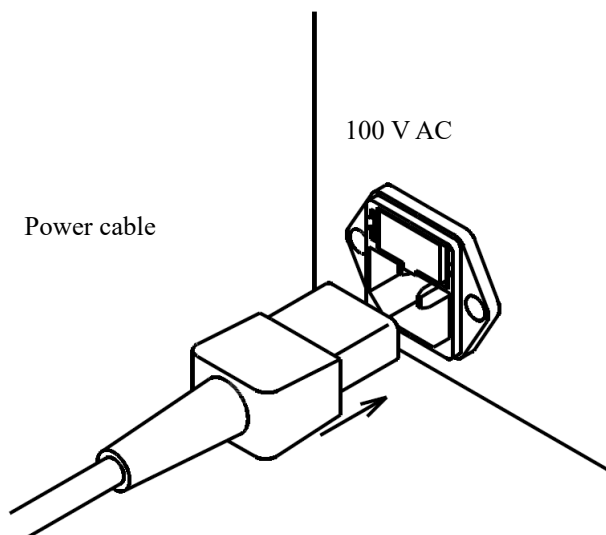

### 6.1.4 Connecting Power Cable to Outlet

Connect the power cable plug to the outlet.

A two-wire adapter is attached to the power cable. To use this, make sure to connect a ground wire to the ground terminal. When the two-wire adapter is removed, the cable can be connected to the outlet for three wires.

**⚠ Caution**      **Make sure to power OFF before connecting.**

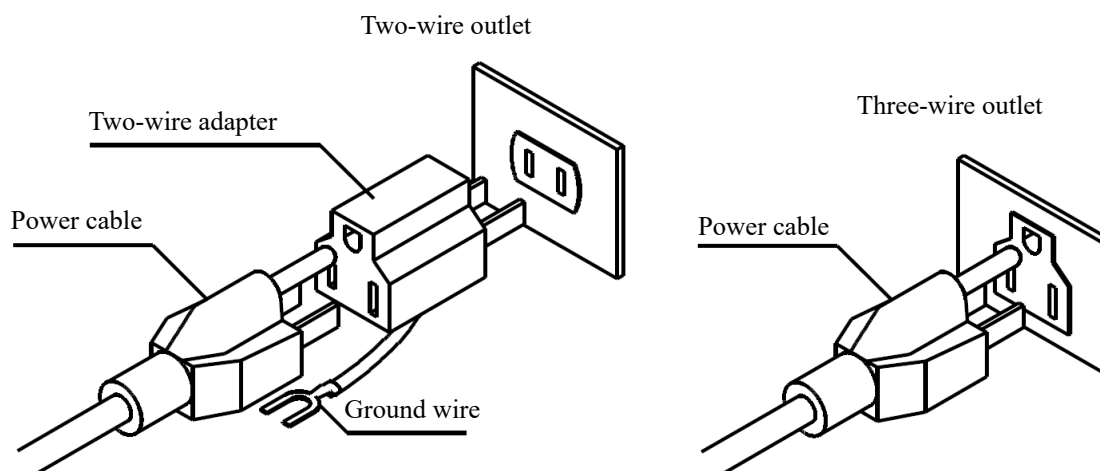

### 6.1.5 Setting AA-size Alkaline Batteries

To perform measurement in locations where 100 V AC power supply cannot be arranged, you can use six AA-size alkaline batteries instead.

Insert the batteries into the battery holders from the rear side of the instrument as shown below.

 **Caution**      **Make sure to power OFF before setting batteries.**

#### NOTE

- Observe correct polarity (+/-) when inserting batteries.
- Remove batteries from the instrument when they are exhausted or the instrument is not used for a long time.
- Do not use a new battery and used battery together. Also, do not use batteries of different types together.
- Battery life depends significantly on the temperature condition.

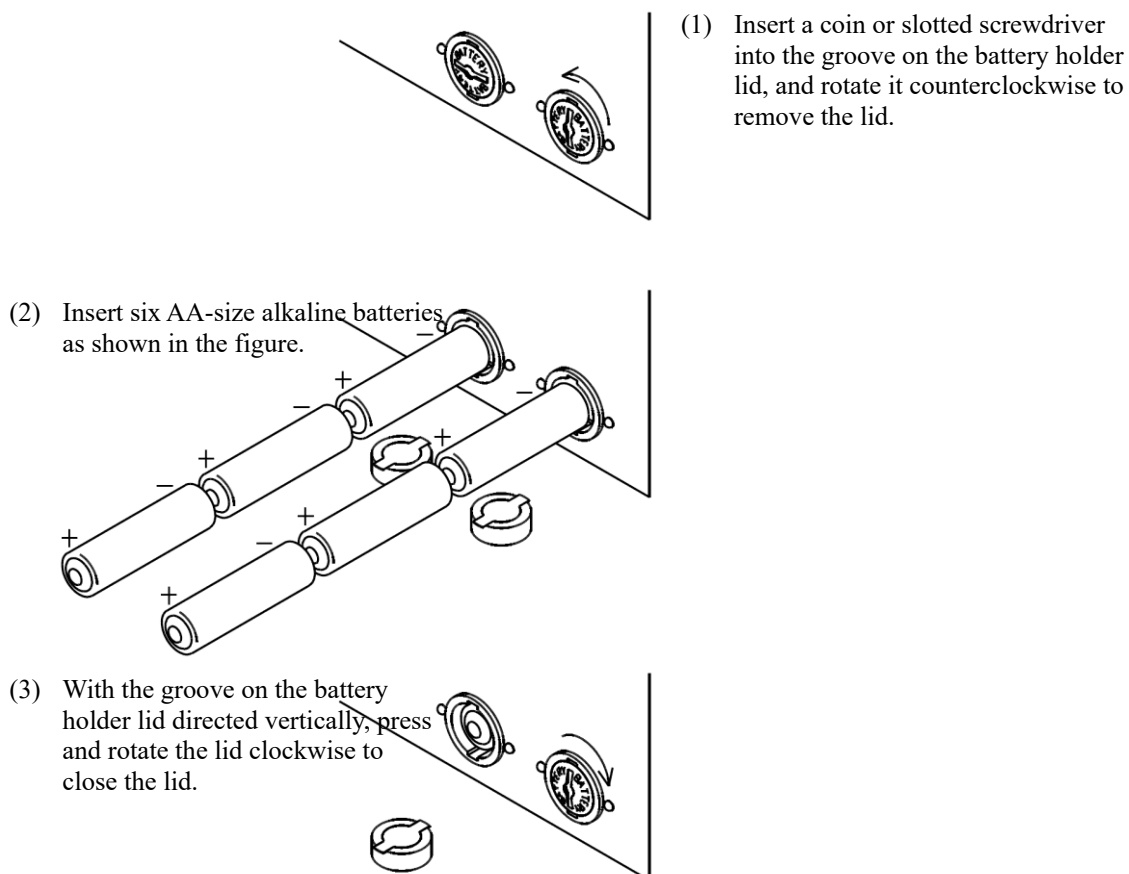

## 6.2 Operating Instructions

### 6.2.1 Power ON

When the preparation of operation is completed, turn on the power switch.

After all LEDs on the display blink for a few seconds, the instrument goes to the measurement standby mode.

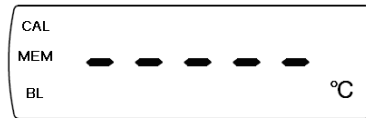

<Measurement standby>

### 6.2.2 Start/Stop Measurement

Measurement can be started by pressing the START/STOP key from the measurement standby mode (lamp on the START/STOP key lights). A measured value is indicated on the display.

When the START/STOP key is pressed during measurement, the measurement stops and the instrument goes to the measurement standby mode.

If “Err”, “OL” or “-OL” is indicated on the display during measurement, it indicates measurement error. See 6.2.7 Error Display and Remedies.

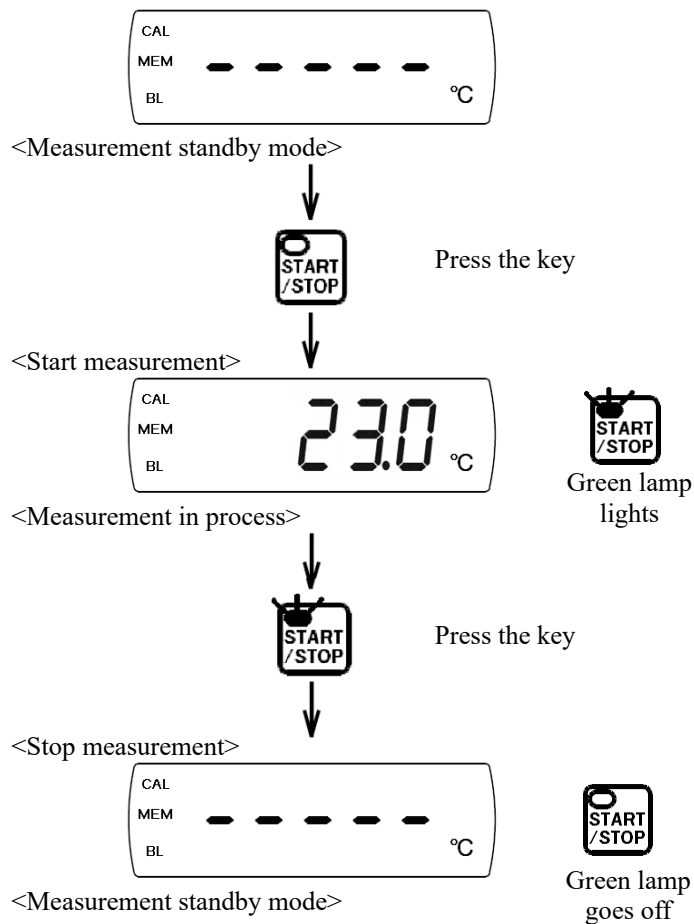

### 6.2.3 Recording Measured Data

- (1) Start recording measured data in internal memory

This instrument can record up to 15,000 data in the internal memory.

To record measured data, **press the MEM key in the measurement standby mode.**

**Confirm that the lamp on the MEM key lights and then start measurement.**

**Measured data will be recorded every second.**

- (2) Stop recording measured data in internal memory

Recording measured data is cancelled when you stop measurement (**lamp on the MEM key goes off**). Measured data per time is recorded as one block, and up to 15,000 data can be recorded in multiple blocks.

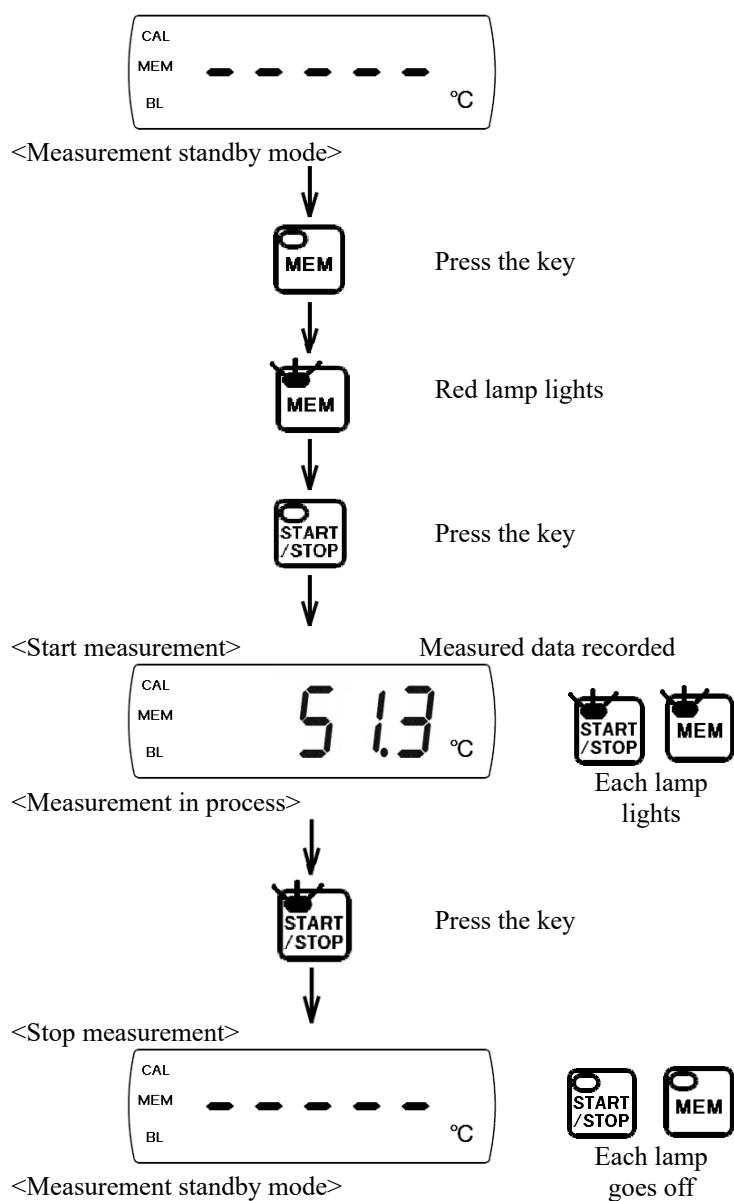



(3) Displaying remaining memory

The remaining memory is indicated on the display while holding down the ENT key.

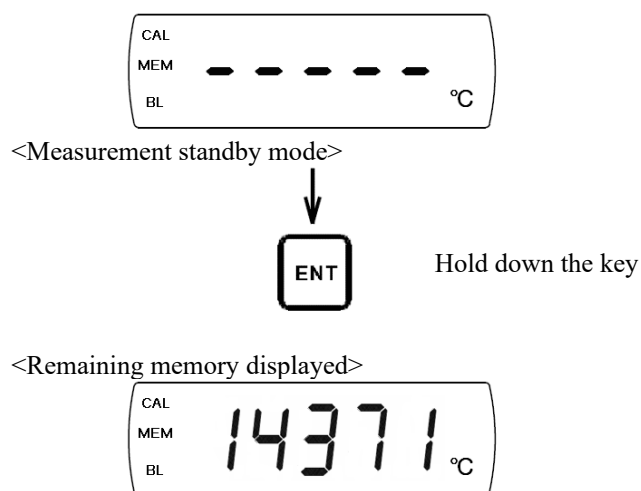

\* This will become unavailable while setting or executing calibration.

(4) Low memory warning

The low memory warning lamp blinks when the remaining memory becomes 300 or lower, and lights steadily when the remaining memory reaches 0. If the remaining memory reaches 0, data record function is disabled (measurement is continued).

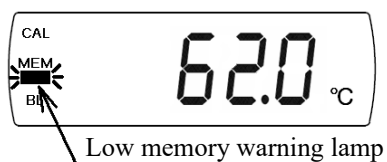

(5) Deleting measured data

To delete data recorded in the instrument, turn off the power switch and then turn on again while holding down the ENT key.

Press the ENT key to check if the remaining memory indicates 15,000.

NOTE

- If you perform this, all data is deleted and it cannot be restored. Be careful not to delete important data.

(6) Low battery warning

The low battery warning lamp lights when the remaining battery level becomes low. In this case, replace batteries promptly according to the procedures given in 6.1.5 Setting AA-size Alkaline Batteries.

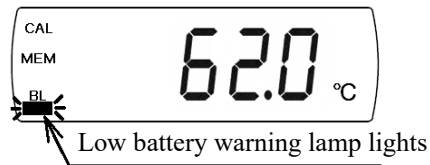

NOTE

- Use AA-size alkaline batteries only.
- Battery life depends significantly on the temperature condition.
- Note that the instrument stops operation temporarily if you connect the AC power cable while operating with batteries, or if you switch the power source from 100 V AC to batteries during operation.

#### 6.2.4 Calibration

For normal measurement, this instrument offers an accuracy of  $\pm 2^\circ\text{C}$ . However, when you need more accurate measurement, use the calibration function.

When calibration is executed, an accuracy of  $\pm 0.5^\circ\text{C}$  can be obtained within a range of up to  $50^\circ\text{C}$  above or below the calibration point.

This instrument actually measures a real temperature for a standard value, and calculates the difference between a measured value and a true value (calibration set value), converting the difference into decay time then adding for calibration.

Therefore, for accurate calibration, real temperature within a measured area and standard thermometer for obtaining accurate standard temperature are necessary.

(We recommend you to use a temperature calibrator for calibration.)

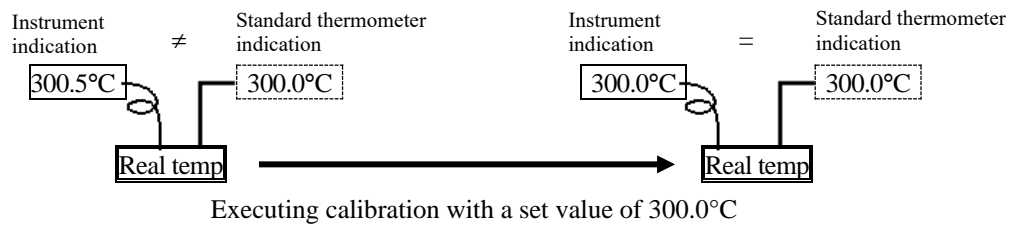

#### NOTE



- Never change the sensor while executing calibration. Variability between sensors may decrease the accuracy.

(1) Setting calibration temperature

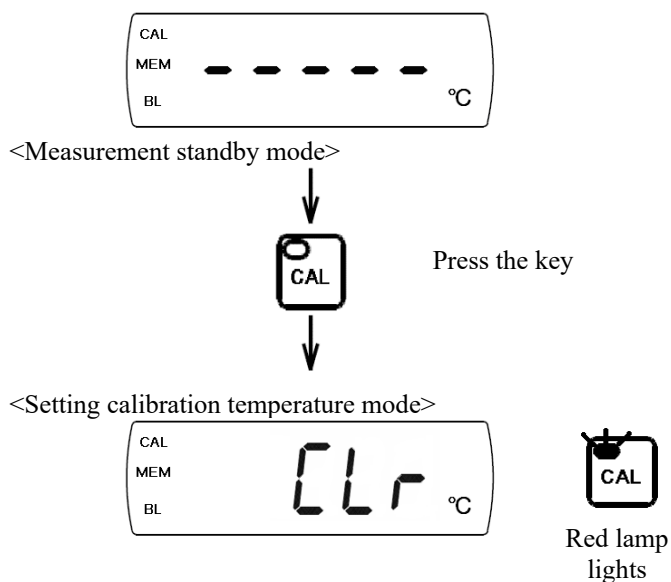
To set the calibration temperature, press the **CAL** key while the instrument is in the measurement standby mode. The mode changes to calibration temperature setting mode, and the display will indicate “┌└┐”.



Temperature can be set when the \* key is pressed while “┌└┐” is shown on the display (pressing the \* key while “┌└┐” is displayed does not allow temperature setting). Set a temperature value for one digit at a time. A blinking digit is ready to be edited.

-  key      Moves digit to edit (editable digit blinks)
-  key      Changes numerical value

Press the **ENT** key to complete temperature setting. The entered calibration temperature is validated and the instrument goes to the measurement standby mode. To start measurement, press the **START/STOP** key.

When you press the **CAL** key instead of the **ENT** key, temperature setting will be cancelled and the measurement standby mode will be recovered.

The setting range is from -195.0 to 450.0°C. If an entered value is out of this range, it is not validated by the **ENT** key. In this case, reset the temperature again.

The calibration temperature validated by the **ENT** key is recorded in the instrument.

(2) Executing calibration

Arrange a real temperature atmosphere (such as 0°C, triple point of water) which is to be a standard value necessary for calibration.

Put the sensor in the arranged real temperature atmosphere and start measurement. Press the **CAL** key when the measured value becomes stable. The set calibration temperature appears and blinks on the display.

Calibration is executed when the **ENT** key is pressed, and the set calibration temperature is indicated on the display. Also, the calibration executing lamp lights while calibration is in process.

When you press the **CAL** key instead of the **ENT** key, calibration is not executed and the instrument goes back to measurement.

Obtained calibration data is recorded in the instrument.

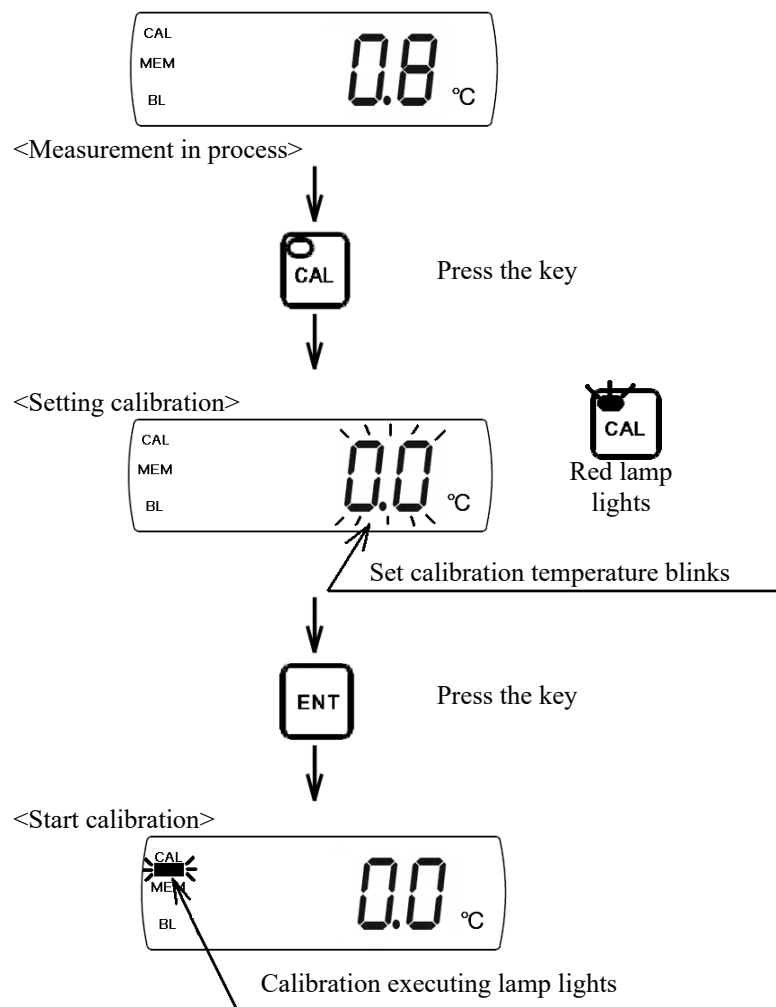

(3) Canceling calibration

Stop measurement by pressing the **START/STOP** key and then press the **CAL** key.

In the calibration temperature setting s, set the temperature to “**CLr**” with the \* key and then press the **ENT** key.

Restart measurement with the **START/STOP** key and then press the **CAL** key. When “**CLr**” is displayed, press the **ENT** key to cancel calibration.

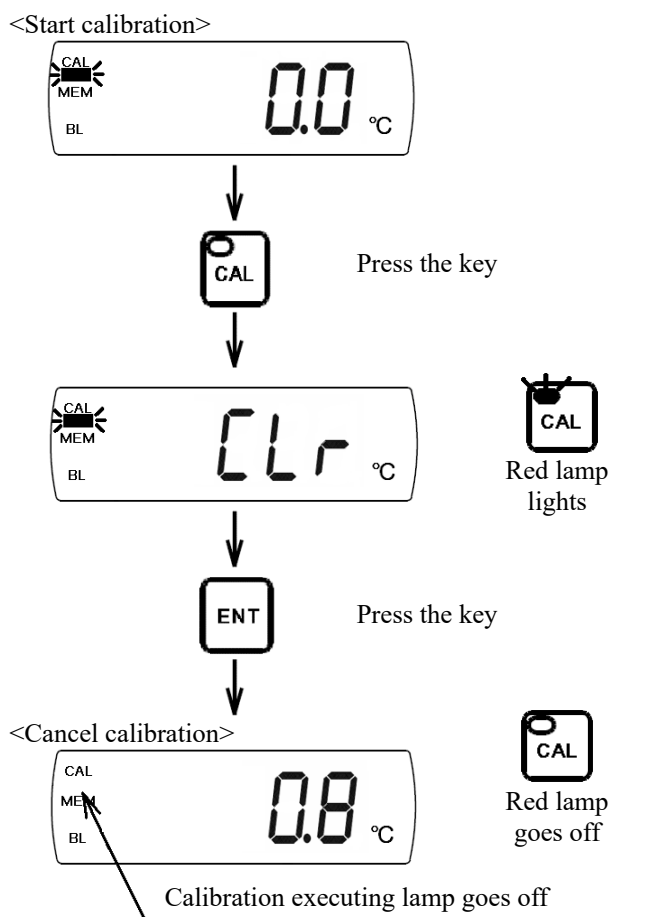

## 6.2.5 RS-232C Communication

### (1) Connecting communication cable

As shown in the figure below, connect a communication cable to the RS-232C connector located on the rear side of the instrument.

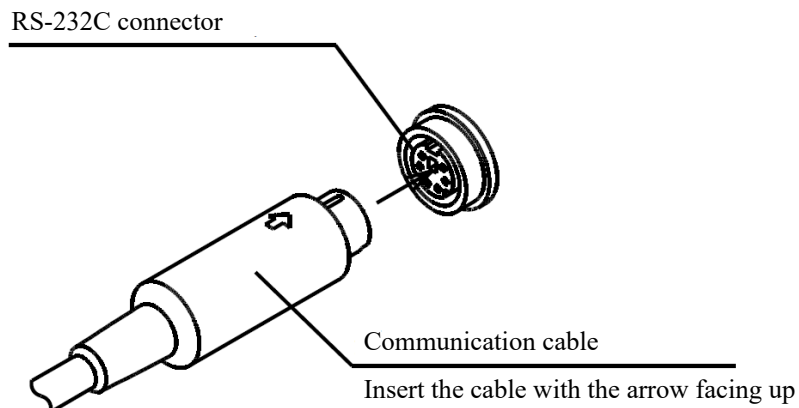

Connect the connector of the other end to a computer.

### (2) Installing software (AMS-850) on your computer

Install the program file of MS-850 from the provided CD-ROM. You cannot start the program from the CD-ROM, so make sure to install the component on the hard disk of your computer and then start up the program.

For more information about installing and operating AMS-850, refer to the provided user's manual for AMS-850

### 6.2.6 Analog Output

Analog output can be made from the analog output connector (ANALOG OUT) located on the rear side of the instrument under the following conditions. Output is made in synchronization with temperature indication, so you can view or record temperature variation by connecting a recorder.

Output range      All measurement range

Output rate        10mV/°C

Resolution        1mV

Pin connection



Pin No.	
A	Signal
B	GND
C	N.C.

Voltage output against temperature indication

Temp indication (°C)	Voltage output (mV)
0.0	0
450.0	4500
-195.0	-1950
Err	4500

(Compatible connector: R05-PB3M produced by Tajimi Electronics)

#### NOTE

- Do not install this instrument and analog output cable in areas subjected to electromagnetic interference. It may damage the instrument or cause measurement error.



### 6.2.7 Error Display and Remedies

(1) “Err” (error), “Or” (over) and “-Or” (minus over)

If “Err”, “Or” or “-Or” is displayed during measurement, it indicates measurement failure caused by a problem such as:

- Sensor not connected.
- Sensor damaged.
- Incompatible sensor connected.
- Measured temperature out of the range of instrument and sensor.

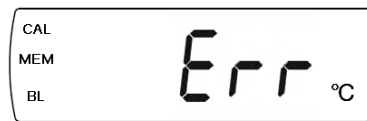

For the case a measured temperature is out of the measurement range of the instrument and sensor, move the instrument and sensor promptly to area where the temperature is within the range to maintain the sensor performance.

Also, check if the specified sensor for the instrument is used, and the sensor is connected properly (see 6.1.1 Connecting Sensor).

If there is no problem in connection, the sensor may be damaged. In this case, please replace the sensor with new one.

When “Err” is still shown on the display even if normality of the sensor is confirmed, please contact your distributor or Anritsu Meter.

## 7. Maintenance

### 7.1 Storing the Product

Avoid a location with any of the conditions listed below when storing this product.

- Exposed to direct sunlight
- Subjected to strong vibration
- High humidity (80% RH or higher)
- High temperature (50°C or higher)
- Subjected to dirt, dust, corrosive gas or salt damage
- Within a strong electromagnetic field

When you are not using the instrument, cover the sensor input part with a cap to store the instrument. We recommend you to store the instrument in the case used at delivery for a long-term storage.

### 7.2 Cleaning Case

If the case becomes soiled, clean it using a cloth slightly dampened with water.

Do not use organic solvents such as thinner and benzine since these may discolor or deform the case or switch.

### 7.3 Relocation

Before relocating the instrument, turn off the power switch and disconnect the power cable and connected devices such as sensor.

Be careful not to drop or bump the instrument against any objects to prevent damages on the instrument.

## 8. Specifications

Input point	1 point
Measurement range	From -195.0 to 450.0°C
Resolution	0.1°C
Accuracy	Calibration not executed: $\pm 2^{\circ}\text{C}$ * $\pm 5^{\circ}\text{C}$ in a range of 400.0-450.0°C Calibration executed: $\pm 0.5^{\circ}\text{C}$ (within $\pm 50^{\circ}\text{C}$ of calibration point) * At an ambient temperature of $25^{\circ}\text{C} \pm 5^{\circ}\text{C}$
Temperature Coefficient	$\pm(0.01\%$ of F.S./ $^{\circ}\text{C})$ , within operating temperatures
Display	Height of character: 15mm, red LED, five digits
Light source	Blue LED (service life: semipermanent)
Operating environment	Temperature: 0 to 40°C, humidity: 15 to 80% RH (non-condensing)
Storage environment	Temperature: -10 to 50°C, humidity: 10 to 85% RH (non-condensing)
Power supply	100V AC $\pm 10\%$ , 50/60 Hz Or six AA-size alkaline batteries (Approx. five hours of continuous operation is possible with use of the alkaline batteries)
Power consumption	Approx. 2 VA
External dimensions	210(W) $\times$ 88(H) $\times$ 230(D) mm (protruded parts excluded)
Weight	Approx. 3kg
Measurement timing	Sampling: every 250ms, display update: every second
Memory	Up to 15,000 data, one second interval (synchronized with display)

Interface	RS-232C Transfer rate: 9600bps Data formation: data length 7bit, odd parity, 1 stop bit
Analog output	Output rate: 10mV/°C Resolution: 1mV Accuracy: $\pm(0.2\%$ of F.S.) (at an ambient temperature of 25°C $\pm$ 5°C) Temperature coefficient: $\pm(0.01\%$ of F.S./°C)
Calibration	One-point calibration (using a real temperature within a measured area)

## 9. Warranty

Our products are carefully inspected before shipment. However, if your product arrives defective due to manufacturing faults or mishandling during transportation, please contact your distributor or Anritsu Meter.

Our products are warranted for one year from the date of delivery. Failure occurred within the warranty period will be repaired with no charge, provided that the failure is attributable to Anritsu Meter.

Please note that the following cases will not be covered by this warranty in any circumstances.

- Failure or damage resulting from natural disaster such as fire, earthquake and flood, or abnormal voltage.
- Failure or damage caused by inappropriate handling such as dropping or giving an impact to the product while it is transported or relocated by the customer.
- Failure or damage resulting from repair or modification performed by any person other than the repair people from Anritsu Meter.
- Failure resulting from external cause, such as a failure of connected devices, or strong magnetic field that exists near the instrument.
- Failure occurred due to non-compliance with the instructions or cautions in this manual.

This product is repaired at Anritsu Meter and we do not visit customers for repair according to our policy. Please note that the shipping charges are at the customer's expense.

The warranty is valid in Japan only.

Note that temperature sensor is not covered by this warranty since it is considered as a consumable part.